

Corn Heads, Draper Heads, Specialty Heads

Full Line Catalog





TABLE OF CONTENTS

ABOUT US	04
GERINGHOFF WORLDWIDE	06
NEW PRODUCTS	10
PRODUCT SELECTOR	12
RESIDUE MANAGEMENT SYSTEMS	14
CORN HEADS	16
CORN HEAD ACCESSORIES	32
SPECIALTY HEADS	34
DRAPER HEADS	40
INTEGRATED AIR SYSTEM (IAS)	48
DRAPER KITS AND DIVIDERS	50
YOUR SATISFACTION DRIVES US	52
TECHNICAL DATA	54



HEAD OF THE CLASS - NO MATTER THE CROP

Geringhoff is one of the world's leading manufacturers and developers of agricultural harvesting machinery. Since our founding in Ahlen, Germany as a small-scale metal forging and farm equipment trade company in 1880, Geringhoff has evolved into world-renowned modern, international engineering company known for our superior harvesting equipment. For over 140 years, our goal has been to increase productivity and make harvesting easier for farmers around the world. Now in the fifth generation, Geringhoff is still family-run today and currently employs more than 500 people across North America and Europe.

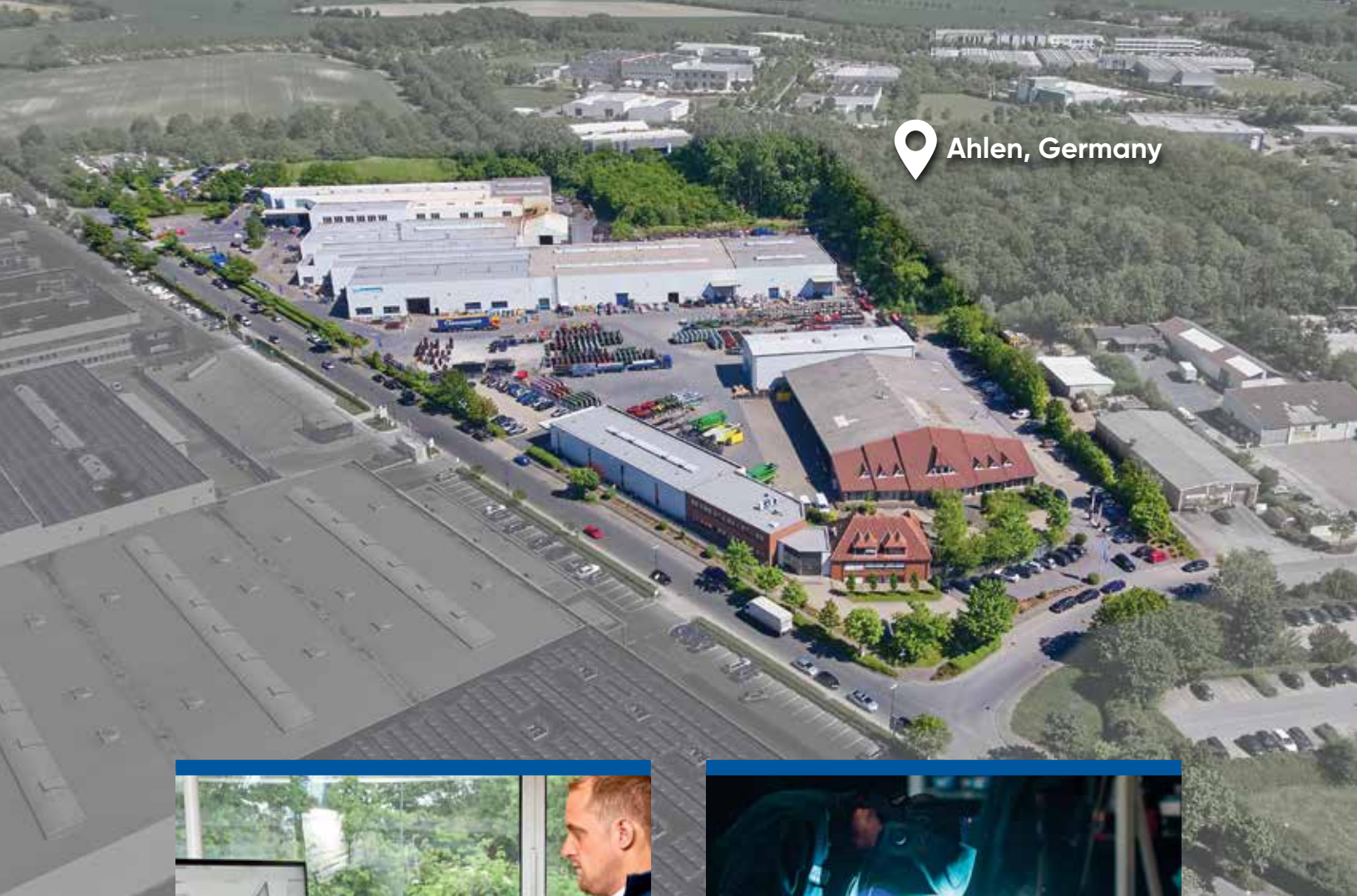

ENGINEERING



PRODUCTION



GENUINE PARTS WAREHOUSE



SERVICE

GERINGHOFF WORLDWIDE

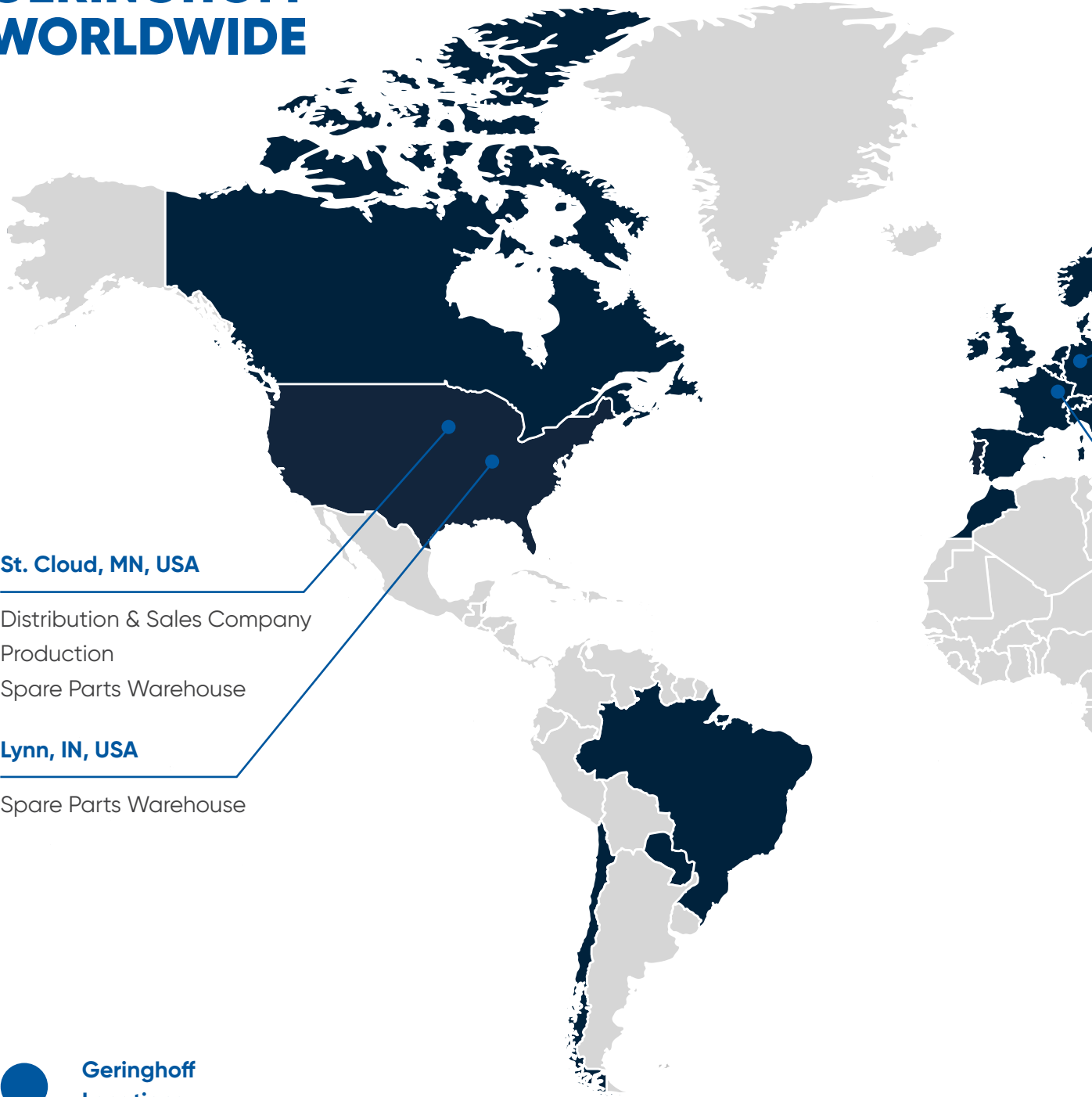

St. Cloud, MN, USA

Distribution & Sales Company
Production
Spare Parts Warehouse

Lynn, IN, USA

Spare Parts Warehouse



**Geringhoff
Locations**



**Geringhoff
Dealers**



Open your phone camera
and scan the QR code
to find a dealer near you

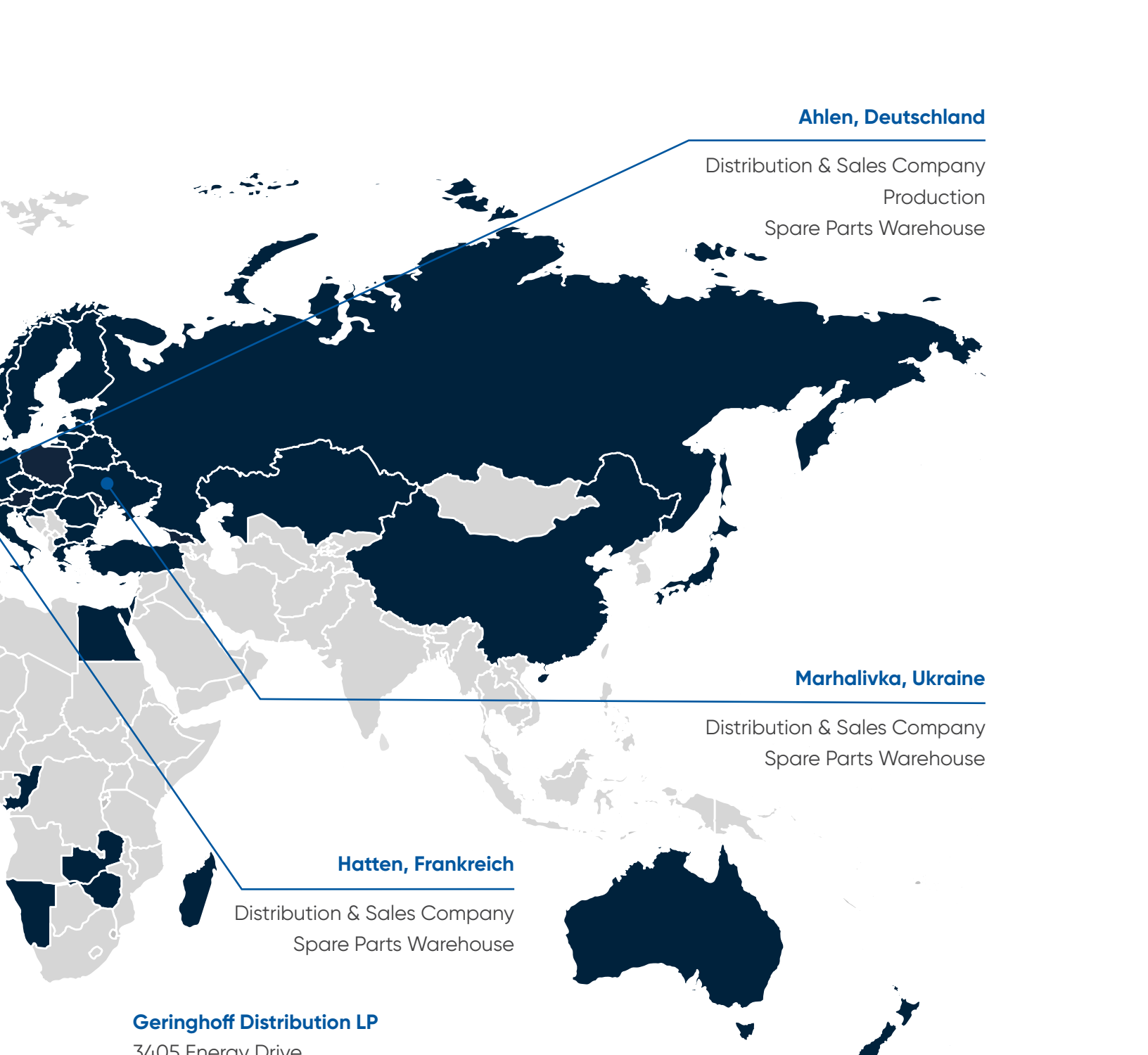

Ahlen, Deutschland

Distribution & Sales Company
Production
Spare Parts Warehouse

Marhalivka, Ukraine

Distribution & Sales Company
Spare Parts Warehouse

Hatten, Frankreich

Distribution & Sales Company
Spare Parts Warehouse

Geringhoff Distribution LP

3405 Energy Drive
St. Cloud, MN 56304
USA

Geringhoff Distribution LP

7496 US-27
Lynn, IN 47355
USA

Carl Geringhoff Vertriebsgesellschaft mbH & Co. KG

Porschestraße 8
59227 Ahlen
Germany

MRA GmbH

14a Route de Wissembourg
67690 Hatten
France

Geringhoff Ukraine LLC

2F, Lisova Str.
Vasylkivskiy distr., Kyiv region
Marhalivka, 08633 Ukraine

THE GERINGHOFF DIFFERENCE



Head of the Class Since 1880

Since our founding in Ahlen, Germany in 1880, Geringhoff has been dedicated to meeting the demands of farmers around the world by evolving harvest innovations and technologies – establishing many industry firsts along the way. Today, our engineers continue that mission using decades of experience to develop harvesting machinery of exceptional quality and maximum functionality. Our steadfast dedication to building heads that are Head of the Class – No Matter the Crop sets us apart from other manufacturers and is the Geringhoff difference.



POSITIVE POWER TRANSMISSION

- ▶ Row units powered by powershaft instead of chain and oil-bath system



EASY MAINTENANCE AND UPKEEP

- ▶ Precise engineering allows convenient maintenance and repair



SPRING LOADED GATHERING CHAINS

- ▶ Consistent maintenance free tension and removal tool for easy chain removal and installation



ADAPTABILITY

- ▶ Combine mounts are changeable to accommodate any major combine make or model



ROW UNIT COUPLING SHAFTS

- ▶ CentaFlex couplers provide for smooth, quiet power transmission
- ▶ Couplers extend gearbox life
- ▶ Make shaft repairs quick and easy



TOUGH GEARBOXES

- ▶ Aluminum gearboxes dissipate heat extending gearbox and oil life
- ▶ Components are precisely machined
- ▶ Internal slip clutch protects gearbox

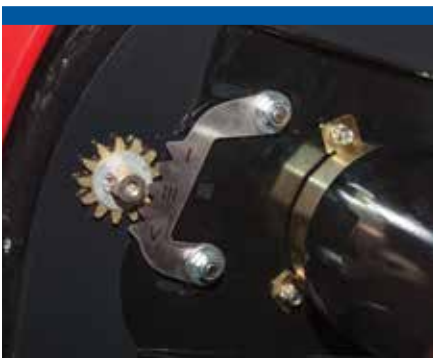

ADJUSTABLE AUGER DEPTH

- ▶ Set auger height to match your conditions

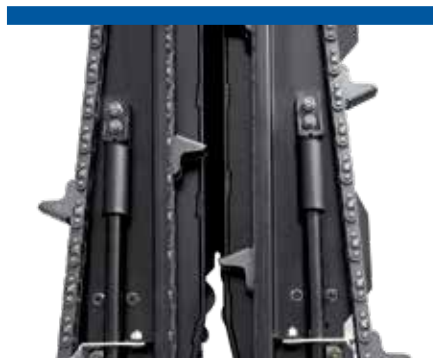

HYDRAULIC DECK PLATES

- ▶ Hydraulically adjustable deck plates easily controlled from combine cab



2-YEAR WARRANTY

- ▶ Industry leading warranty
- ▶ Peace of mind while you harvest

NEW PRODUCTS



AFT (Adaptive Flex Technology)

AFT is the newest offering in our lineup of products. This flexible corn head is specially designed for harvesting in uneven and hilly terrains. The AFT head has a pivot point in the center of the frame that gives farmers the flexibility to adapt their corn head to the contours of their fields while maximizing yield potential in difficult landscapes.

- ⊕ Flexible frame to help maximize yield potential on hilly terrain
- ⊕ Fully automatic height and flex control
- ⊕ Compatible with NorthStar, NorthStar XDC & Rota Disc residue management systems
- ⊕ Available in 12, 16, and 18 row configurations with 30" spacing
- ⊕ Flex range ± 8 degrees
 - 12 rows = 50" total flex range
 - 16 rows = 68" total flex range
 - 18 rows = 75" total flex range

AFT
Adaptive Flex Technology



Learn more. Activate your camera, scan the QR code to learn more about the AFT!

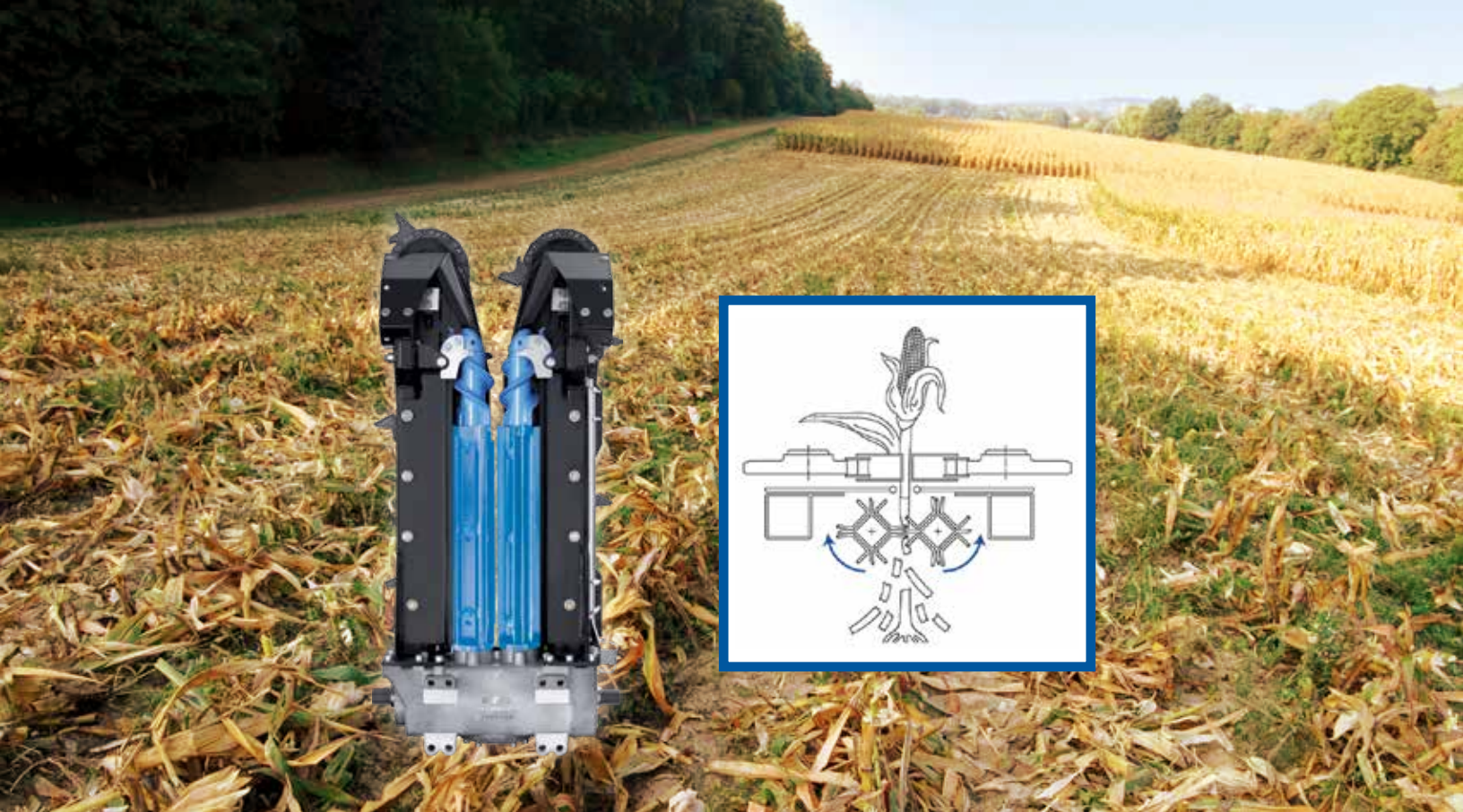

NorthStar XDC Rolls (Xtreme DeComposition)

The NorthStar XDC Rolls are our newest chopping residue management rolls. They are an upgrade to our standard NorthStar knife rolls which have been in the Geringhoff product line since 2001. The NorthStar XDC Rolls crimp, rip, and dice corn residue into 2.5"-3.5" pieces and places them around the stubble causing rapid decomposition of both the residue and stubble.

- ➕ Ideal for no-till and strip-till farming
- ➕ Provides better seed to soil contact for improved germination and higher yield potentials
- ➕ Reduces erosion and keeps straw in the field to break down into organic matter
- ➕ 4 bolted and carbide coated knives for a total of 8 cutting edges and 24 contact points
- ➕ Long lasting blades allow for trouble-free maintenance and are easy to replace as needed
- ➕ No speed adjustments needed from standard rolls
- ➕ Specially designed for our row units and drive lines - Guaranteed to last



Learn more. Activate your camera, scan the QR code to learn more about our NorthStar XDC Rolls!

Product Selector

Choose the gathering and residue management system that suits your field.

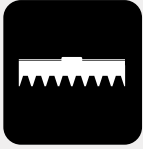

Rigid Model



Folding Model



Row Spacing



AFT
(Adaptive Flex
Technology)

RESIDUE MANAGEMENT

NorthStar System

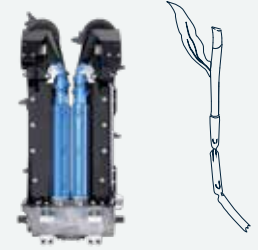

Non-Chopping

- 4" - 6" stalk segments
- Distributed centrally over the row
- Fractured Stubble

GATHERING SYSTEM

Elite XL Series

Conventional Gathering System

Industry exclusive 4" composite idler and proprietary gathering chains. Extended wear performance.



NorthStar

- 4 - 24 rows
- 4 - 24 rows
- 20" - 40" spacing
- 12, 16, 18 rows | 30" spacing

Patriot Series

Wide-Angle Gathering System

Two smaller idlers, angled to provide a 12" opening for gathering twin rows, point rows, and better feeding when drifting off the row. No more ear loss from "whipping."

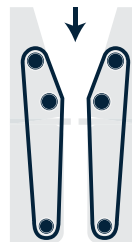

Patriot NorthStar

- 4 - 24 rows
- 4 - 24 rows
- 20" - 40" spacing
- 12, 16, 18 rows | 30" spacing

Freedom Series

SlimLine Gathering System

Gathering chain guides set on a 45° angle allow for 2 chains per row in a very narrow configuration for harvesting in 15" row spacings. Proprietary chains use an angled lug to reduce shelling and ear bounce.

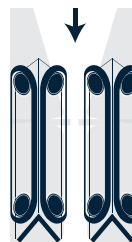

Freedom NorthStar

- 12, 16, 24, 32 rows
- 15" spacing

NorthStar Horizon System

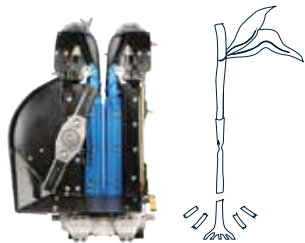

Chopping

- 2" - 4" stalk segments
- Distributed evenly across the field
- Clean cut Stubble

NorthStar XDC System

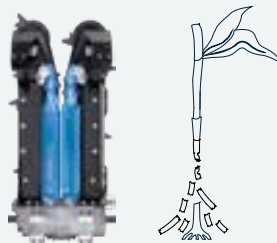

Chopping

- 2 1/2" - 3 1/2" stalk segments cut into small pieces
- Reduces erosion and keeps straw in the field to break down into organic matter
- Ideal for no-till and strip-till farming

Rota Disc® System

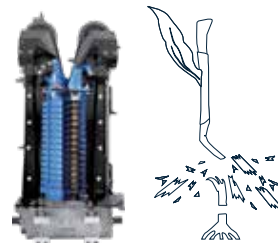

Chopping

- 1" - 3" stalk segments vertically sliced
- Distributed downward and evenly across the field
- Exploded stubble using stubble knife

NorthStar Horizon

- 4 - 18 rows
- 4 - 18 rows
- 20" - 40" spacing

NorthStar XDC

- 4 - 24 rows
- 4 - 24 rows
- 20" - 40" spacing
- 12, 16, 18 rows | 30" spacing

Rota Disc

- 4 - 24 rows
- 4 - 24 rows
- 20" - 40" spacing
- 12, 16, 18 rows | 30" spacing

Patriot NorthStar XDC

- 4 - 24 rows
- 4 - 24 rows
- 20" - 40" spacing
- 12, 16, 18 rows | 30" spacing

Patriot Rota Disc

- 4 - 24 rows
- 4 - 24 rows
- 20" - 40" spacing
- 12, 16, 18 rows | 30" spacing

Freedom Rota Disc

- 12, 16, 24 rows
- 15" spacing

PLEASE NOTE: Geringhoff proudly offers the widest variety of row spacing options and harvest solutions to give you the ultimate harvest. Don't see what you need here? We can help! Please discuss your special needs with your dealer or Geringhoff representative.

RESIDUE MANAGEMENT SYSTEMS



NorthStar

Processing

The NorthStar features four knives and four angles on each snapping roll are directly opposed to provide maximum stalk cutting from a knife-roll style row unit. With the lowest horsepower requirement in the industry, the NorthStar row unit crimps the stalk while distributing the corn residue directly over the harvested row.



NorthStar Horizon

Processing

The NorthStar Horizon row unit combines the NorthStar style snapping rolls with a “swinging blade” to process the corn stalk and leave clean cut stubble. The side-mounted horizontal chopper is placed to maximize residue processing and leave short uniform stubble distributed evenly across the field. Simply engage or disengage the two swinging blades to process the stalks as desired.



NorthStar XDC

Processing

The NorthStar XDC Rolls are a corn residue management upgrade to our "work horse" NorthStar rolls, which have been a staple of the Geringhoff line for years. These rolls, which are superior in residue management, crimps, rips and dices corn residue into 2.5-3.5" pieces and windrows them so that they settle around the stubble causing rapid decomposition.



Rota Disc®

Processing

The Rota Disc provides the most efficient residue processing available. A patented 3 roll system with inter-meshing chopping shaft (15 carbide knives) is a modern marvel. The Rota Disc system shreds and distributes in a downward motion leaving an even layer of material across the harvested area. This allows for rapid decomposition and breakdown of the stalk material.

CORN HEADS





NEW!

AFT
Adaptive Flex Technology



AFT (ADAPTIVE FLEX TECHNOLOGY)

CORN HARVESTING MADE EASY IN HILLY, UNEVEN TERRAINS

AFT is our newest corn head specially designed for harvesting on terraces and hilly terrains. The AFT head has a pivot point in the center of the frame that gives farmers the flexibility to adapt their corn head to the contours of the land while maximizing yield potentials in difficult landscapes.



Available in red, Midnight Harvest®, and most major combine colors



+ Flexible frame to help maximize yield potential on hilly ground

+ Fully automatic height and flex control

+ Flex range ± 8 degrees

- 12 rows = 50" total flex range
- 16 rows = 68" total flex range
- 18 rows = 75" total flex range



+ Available in 12, 16, and 18 row configurations with 30" spacing

+ Compatible with NorthStar, NorthStar XDC, and Rota Disc residue management systems



FREEDOM

SETTING NEW STANDARDS IN 15" ROW CORN HARVESTING

The Freedom corn head features patented SlimLine™ design row units with gathering chains set on a 45° angle allowing for 2 chains per row in a narrow 15" configuration. Chain lugs gently deliver the ears to the trough and then return vertically to help keep the deck clean.

Additional options include the ICF Sweeper and Headsight.

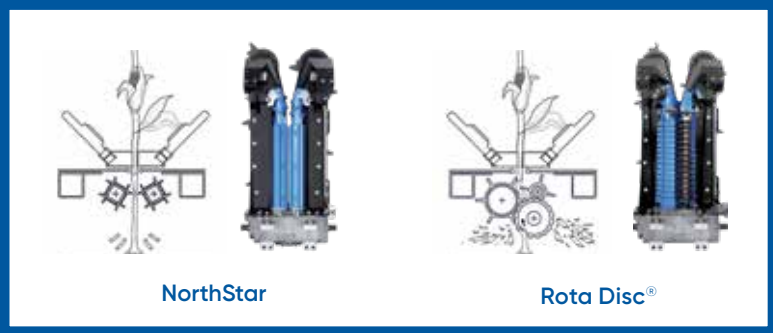

Available in green, Midnight Harvest®, and most major combine colors



- ⊕ Each row has an internal slip clutch to protect against breakdowns
- ⊕ Aluminum gearboxes dissipate heat extending the life of the machine and oil
- ⊕ CentaFlex Couplers between each row unit relieves pressure from gearbox
- ⊕ Low profile frame, LED illumination kit, and stainless steel wear protectors on poly
- ⊕ Compatible with NorthStar and Rota Disc residue management systems
- ⊕ Standard end row augers bring ears into the auger trough without losing them

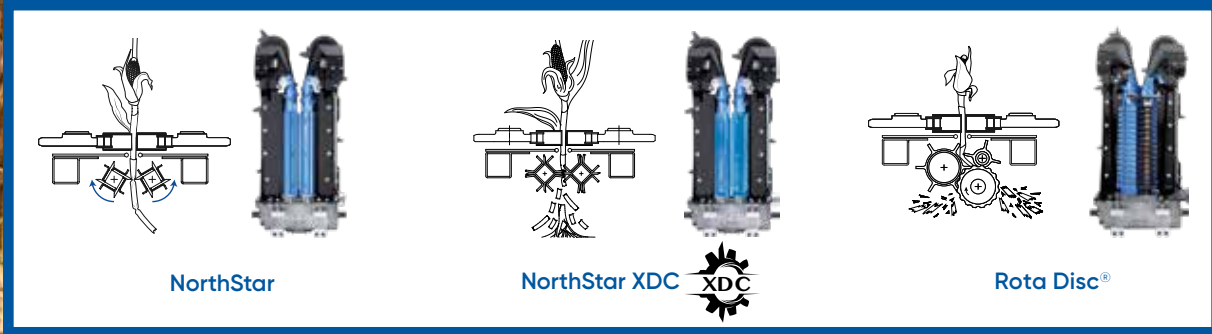

PATRIOT

THE MOST FORGIVING HEAD ON THE MARKET

The Patriot corn head, with its wide angled gathering system, provides flexibility for the operator to harvest single or twin rows, and offers row forgiveness when harvesting directly on the row is a challenge. The innovative design of the Patriot is engineered to deliver outstanding performance no matter the conditions.

Additional options include the ICF Sweeper and Headsight.



Available in Midnight Harvest®
and most major combine colors



- ⊕ Wide angled deck plates offer forgiveness on uneven ground and wide row harvesting
- ⊕ Double-acting hydraulic deck plate adjustment
- ⊕ Quick attach ear savers keep crop moving from collection and reduces lost yield
- ⊕ LED illumination kit and wear protectors on poly
- ⊕ Compatible with NorthStar, NorthStar XDC, and Rota Disc residue management systems
- ⊕ Standard end row augers bring ears into the auger trough without losing them

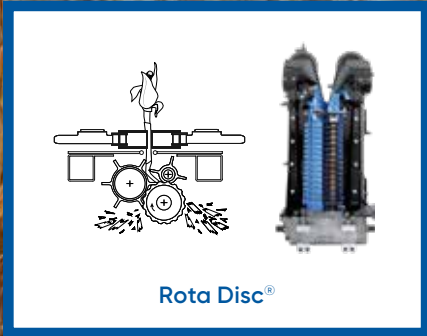

ROTA DISC

THE MOST EFFICIENT CHOPPING SYSTEM ON THE MARKET

The Rota Disc is the only true vertical stalk slicing and shredding corn head on the market. Designed to thoroughly process residue evenly on your field while using less than half the horsepower required by most chopping heads, the Rota Disc saves you time, money, and energy in the field. Its vertical stalk slicing technology exposes the inside of the stalk and starts the decomposition process immediately.

Additional options include the ICF Sweeper and Headsight.



Available in yellow, Midnight Harvest®, and most major combine colors



- + Slip clutch protects against foreign objects
- + Aluminum gearboxes dissipate heat extending the life of the machine and oil
- + Patented gearbox utilizes a 3 roll system with no additional gearbox for chopping
- + Destroys stubble tops for faster breakdown and reduced tire damage
- + Evenly spread residue makes this the perfect head for no-till farms
- + LED illumination kit and stainless steel wear protectors on poly
- + Compatible with Rota Disc residue management systems
- + Standard end row augers bring ears into the auger trough without losing them



NORTHSTAR

TIME TESTED WORKHORSE FOR ALL CONDITIONS

The NorthStar offers an exceptionally smooth and quiet running system, despite its fierce appetite in the field. Aside from removing the ears, it processes the stalk allowing for greater breakdown and post harvest tillage.

Additional options include the ICF Sweeper, Headsight, and Passive or Active Sunflower Kits.

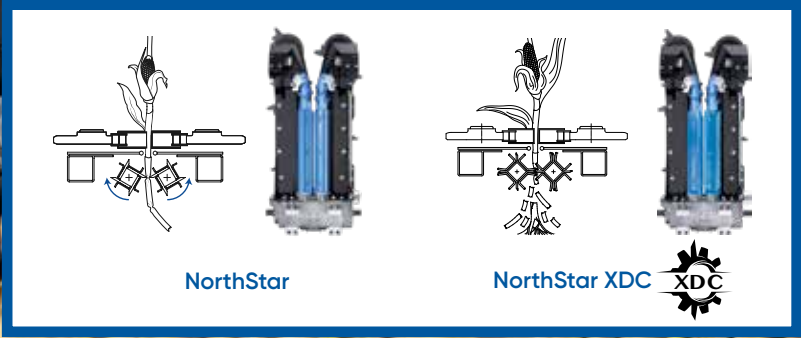

Available in red, Midnight Harvest®, and most major combine colors



- ➕ NorthStar knife rolls have 8 total contact points and the NorthStar XDC knife rolls have 24 total contact points for positive feeding
- ➕ Aluminum gearboxes dissipate heat extending life of machine and oil
- ➕ Spring tension, self tightening chain
- ➕ Replaceable knives are hardened steel and carbide / hard coated
- ➕ Great for higher harvest speeds, low maintenance, and dependable
- ➕ LED illumination kit and stainless steel wear protectors on poly
- ➕ Compatible with NorthStar and NorthStar XDC residue management systems
- ➕ Standard end row augers bring ears into the auger trough without losing them

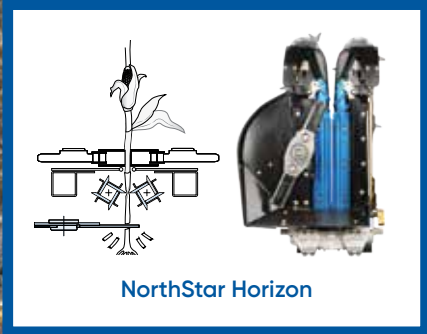

NORTHSTAR HORIZON

BEST IN STALK BUSTING PRECISION, DESIGNED FOR DURABILITY AND LONGEVITY

The NorthStar Horizon allows you to harvest the way you want with the option of chopping or not chopping your residue. Engage the swinging blades for a uniform finely chopped field or disengage them if you would like to leave longer residue. When the chopper is shut off, select between minimum and maximum processing by simply moving the selector on each row unit.

Additional options include the ICF Sweeper and Headsight.



Available in green, Midnight Harvest®, and most major combine colors



- ⊕ Consistent distribution of crop residue leaves field with a clean, uniform cut
- ⊕ Aluminum gearboxes dissipate heat extending life of machine and oil
- ⊕ Triple row unit gearbox protection (rollers, chopper, gathering chains)
- ⊕ Easily accessible swing blade slip clutch
- ⊕ Quick change chopping knives are hardened on both sides, making them reversible for extended life
- ⊕ Designed to hold material a little longer to mulch residue
- ⊕ LED illumination kit and stainless steel wear protectors on poly
- ⊕ Compatible with NorthStar Horizon residue management systems



NorthStar Horizon Stover Collect

NORTHSTAR HORIZON SC

WORKING DOUBLE DUTY TO HARVEST AND WINDROW

The NorthStar Horizon Stover Collect completes two operations in a single pass; it harvests your crop and gathers the stover from the entire work width into a central swath. Leaving material perfectly positioned for further processing. Select minimum or maximum processing with a simple engagement lever on each row unit.

Additional options include the ICF Sweeper and Headsight.



Available in orange,
Midnight Harvest®, and most
major combine colors



- ⊕ Stover collection design collects the chopped residue and forms a windrow in the center of the harvested area
- ⊕ Aluminum gearboxes dissipate heat extending life of machine and oil
- ⊕ Triple row unit gearbox protection (rollers, chopper, gathering chains)
- ⊕ Centered windrows allow for quick and easy baling
- ⊕ Windrowing can be 'shut off' by covering the collecting auger
- ⊕ Quick attach ear savers keep crop moving for collection and reduces lost yield
- ⊕ LED illumination kit and stainless steel wear protectors on poly
- ⊕ Compatible with NorthStar Horizon residue management systems

CORN HEAD ACCESSORIES AND FEATURES



ACTIVE SUNFLOWER KIT

- ▶ Available for NorthStar corn heads



PASSIVE SUNFLOWER KIT

- ▶ Available for Rota Disc and NorthStar corn heads



SUNFLOWER ADAPTER SCREEN

- ▶ Redirects sunflower seeds into the trough for maximum yield retention



AHHC SYSTEM

- ▶ Automatic head height control systems integrate effortlessly with the combine
- ▶ All Headsight® systems are factory installed
- ▶ See page 33 for details



ICF SWEEPER

- ▶ Integrated Crop Flow sweeper improves crop flow in adverse conditions
- ▶ Increase harvest speed in down and extremely dry corn



FOLDING SYSTEM

- ▶ Fast, effortless transport with the push of a button
- ▶ All drivelines are coupled automatically to ensure all header sections are properly connected
- ▶ Reliable operations with hinged hood sections that lock and open hydraulically

HEADSIGHT®



Industry-leading head height control by Headsight is offered direct from Geringhoff. This factory-installed option is a valuable addition to your Geringhoff head. It provides exceptional height control and adds precise response to challenging terrain conditions.

Corn Sensor

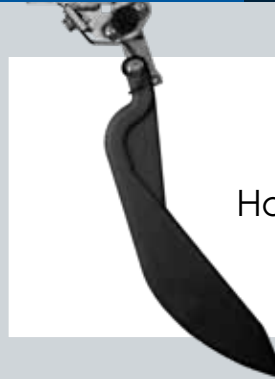

Sensor system with Insight® or Horizon® controllers with Foresight®



HORIZON® CONTROLLER

Headsight's Horizon controller offers the most advanced head control and diagnostics at your fingertips. It uses the existing OEM VT display, enabling the operator to update settings, view diagnostic info, and perform calibrations without ever leaving the cab. Additional parts from Headsight may be required to utilize VT.



INSIGHT® CONTROLLER

The Insight interface controller surpasses OEM and direct wire head height performance by adding features and advanced settings. The Insight controller increases the maximum number of analog height sensors to five and offers improved height control.

Choose between 2, 3, 4, or 5 sensors

FORESIGHT® FEATURE

The best head control at low operating heights. Height control loses 50–75% of its responsiveness while the snout tips are touching the ground. Foresight magnifies the responsiveness of the head height control to improve performance when the snout tips are on the ground.

Foresight detects when the snout tips touch the ground (by using a calibration point), and magnifies the sensitivity below that point, giving the same (or better) head control responsiveness with the tips on the ground than off the ground.

HEADSIGHT CONTROLLER AVAILABILITY

Corn Head Model	Insight with Foresight	Horizon with Foresight
Rota Disc	X	X
NorthStar	X	X
Horizon	X	X
Patriot	X	X
Freedom		X

SPECIALTY HEADS





GERINGHOFF
SunLite 25

NOW IN
MIDNIGHT HARVEST



SUNLITE

BEST CHOICE FOR COMMERCIAL SUNFLOWER HARVESTING

The SunLite head uses 7" wide tapered pans to gently capture sunflower crop, guiding it to the cutter bar while the integrated seed catcher prevents seeds from dropping to the ground. Its curved auger trough design results in an optimum crop flow and the gentle handling of the crop greatly reduces losses. Using reliable mechanical drives for the feed roller, auger, and sickle blade, the SunLite requires less power than the competition.

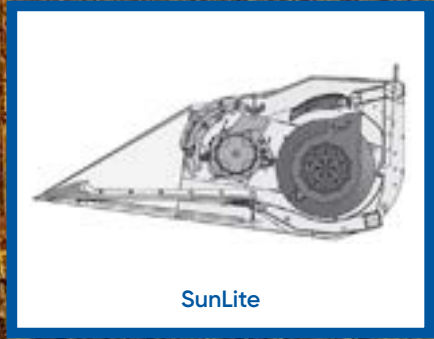

SunLite



- + Row-free technology allows harvest in any direction
- + Wear-resistant trough-shaped collection pans
- + Shatter-loss grooves ensure maximum versatility for varying row spacing
- + Adjustable 24" diameter feed auger
- + Slim side panels to prevent crop loss
- + Maximize combine capacity and maintain higher ground speeds
- + Reliable mechanical drives require less power than the competition



MILOSTAR

SUPERIOR IN HARVESTING GRAIN SORGHUM

The MiloStar is the only row unit on the market engineered specifically for grain sorghum and is built for any crop condition - including weather-damaged crops. The positive drive cutting system cuts high and clean to keep you moving while seed-capture row dividers keep the crop in the trough and deliver it to the combine.



- ⊕ Steel flat top bonnets
- ⊕ Clips the heads, leaves the stalks behind
- ⊕ Triple hardened cutting discs power through wet conditions and shear closer to the head of the pant
- ⊕ Harvest lower moisture crop (down to 14%) without loss or shatter
- ⊕ Row-type header reduces the amount of materials - other than grains - that go through the combine which increases harvest efficiency

DRAPER HEADS





ADAPTS TO YOUR TERRAIN WITH UNIFORM CROP FLOW

+ Large cross auger (13.8")

Ensures optimal crop flow in high volume conditions (optional)

+ Three-section frame³

Contours to uneven terrain with exceptional crop flow in all conditions



+ Narrow side panels due to central cutterbar drive

Minimize losses with 4" end panels

+ Large center fed auger (24.5" diameter)

Optimal feeding of the crop to the combine

+ Flexible cutterbar (up to 6")

Harvest closer to the ground with a cutterbar that flexes up to 6" of contouring travel

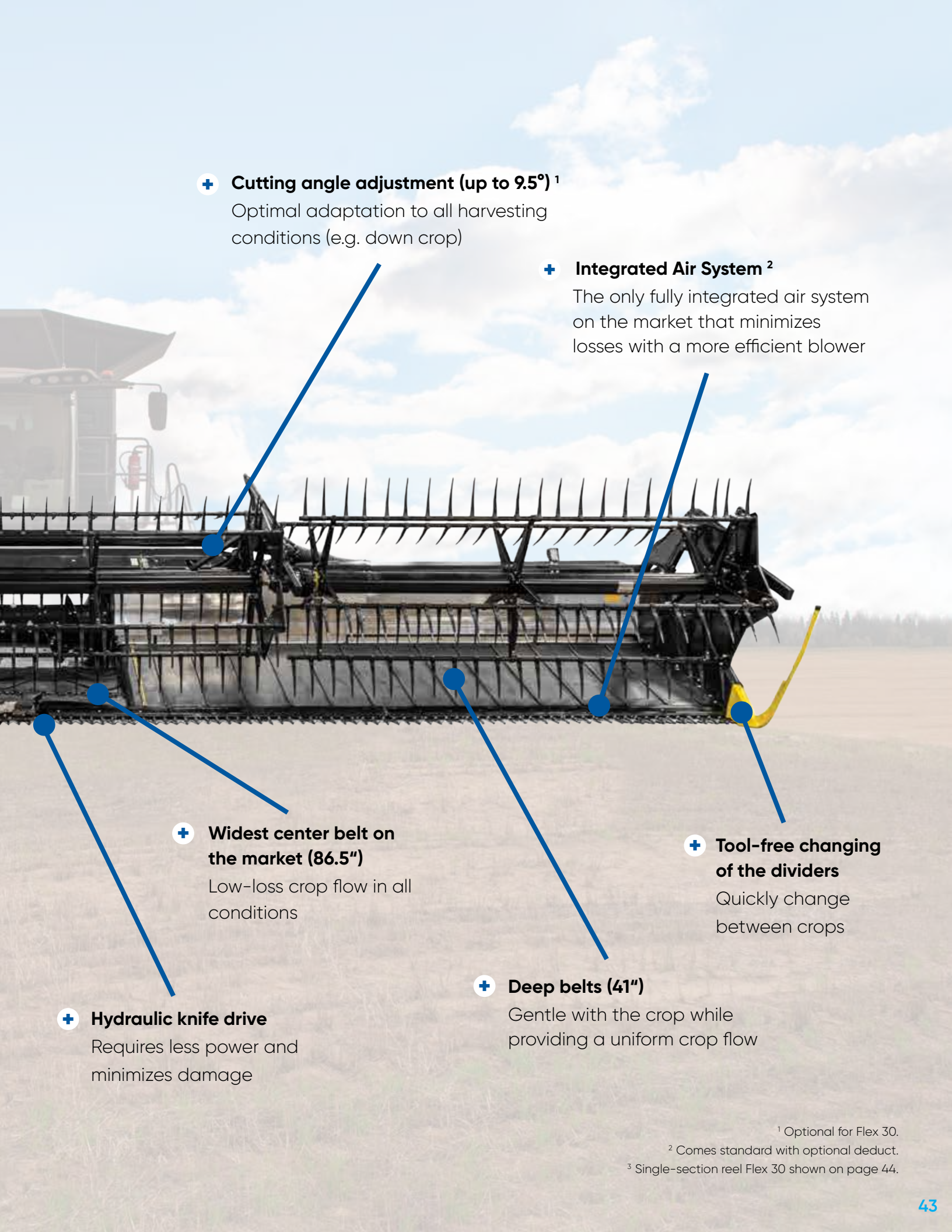

+ Cutting angle adjustment (up to 9.5°) ¹

Optimal adaptation to all harvesting conditions (e.g. down crop)

+ Integrated Air System ²

The only fully integrated air system on the market that minimizes losses with a more efficient blower

+ Widest center belt on the market (86.5")

Low-loss crop flow in all conditions

+ Tool-free changing of the dividers

Quickly change between crops

+ Hydraulic knife drive

Requires less power and minimizes damage

+ Deep belts (41")

Gentle with the crop while providing a uniform crop flow

¹ Optional for Flex 30.

² Comes standard with optional deduct.

³ Single-section reel Flex 30 shown on page 44.

UPGRADED!



TRUFLEX RAZOR

FLEXIBLE FRAME, FLEXIBLE CUTTERBAR, FLEX POINT REEL

The TruFlex Razor is still the most flexible, ground following draper on the market. Featuring a 3-section flex-point reel and frame, as well as a flexible cutterbar, the TruFlex Razor offers exceptional contouring and is unmatched when harvesting on uneven terrain. Separate height control systems¹ for grain and soybean harvesting are controlled by Geringhoff's monitor. Upgraded Integrated Air System (IAS) comes standard (optional deduct).

Available options include the Canola Kit with a cross-feeding auger and vertical knives.

¹ Grain height control system is optional in the US.



- ⊕ Contours and adapts to the terrain
- ⊕ Uniform cutting and stubble height and minimizes crop loss
- ⊕ Center drive allows for narrow profile with 4" end panels
- ⊕ Wings flex 4° up and 5° down for a total of 9° of flex
- ⊕ Flexible cutterbar up to 6" of contouring travel
- ⊕ Industry's first three-section flex-point reel
- ⊕ Upgraded, easy open side panel door

UPGRADED!



FLEX 30

RIGID FRAME, FLEXIBLE CUTTERBAR, RIGID REEL

The Flex 30 is equipped with a rigid frame, a single-section reel, and a flexible cutterbar suitable for versatile harvesting. Equipment options include height adjustment for grain and legumes. Harvest closer to the ground and easily control it through a separate terminal.

Available options include the Canola Kit with a cross-feeding auger and vertical knives.

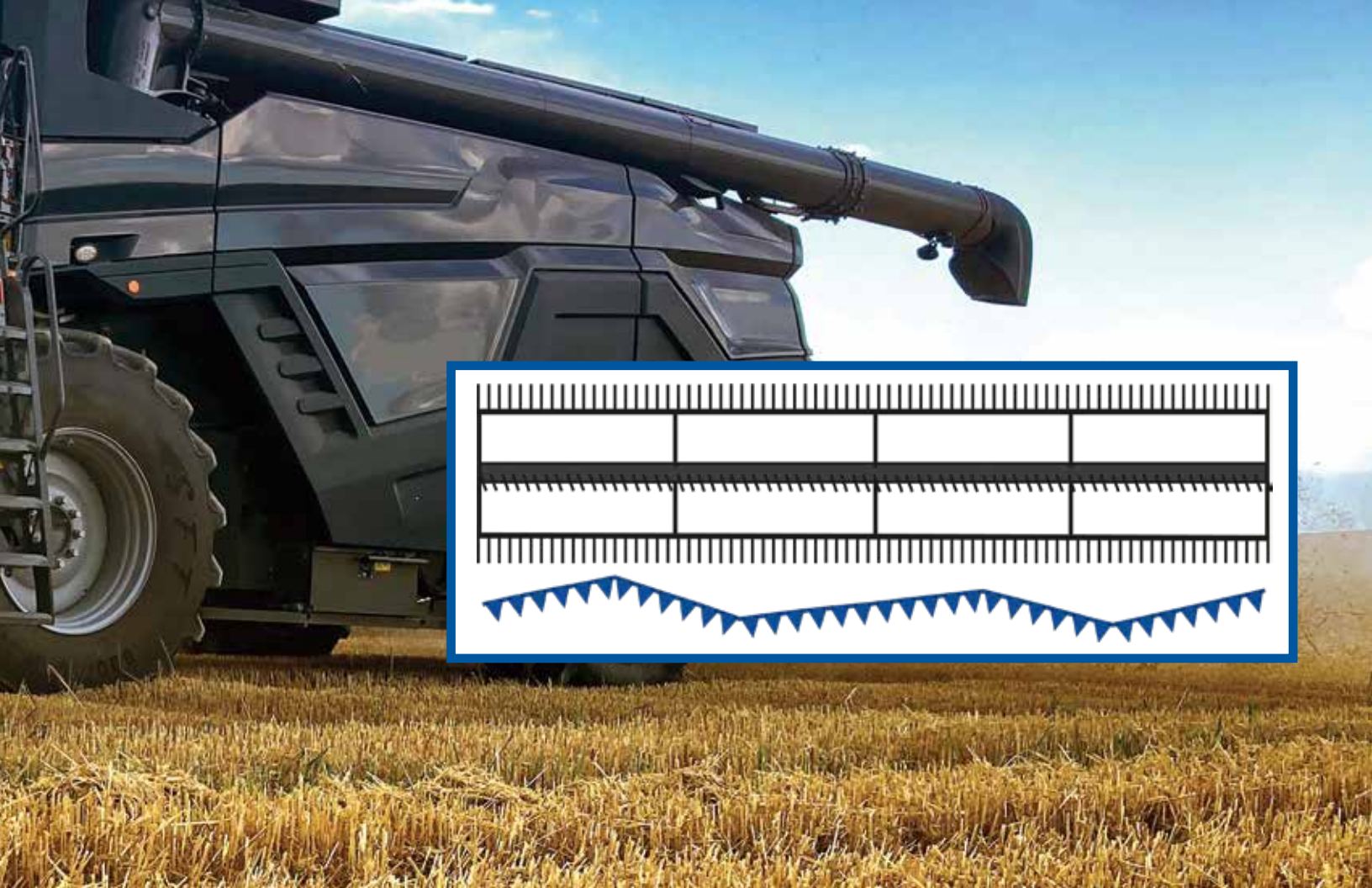

- ⊕ Double knife system with overload protection
- ⊕ Uniform cutting and stubble height and minimizes crop loss
- ⊕ Center drive allows for narrow profile with 4" end panels
- ⊕ LED Lighting and adjustable belt speed
- ⊕ Flexible cutterbar up to 6" of contouring travel
- ⊕ Upgraded, easy open side panel door



INTEGRATED AIR SYSTEM

The Flex 30 and TruFlex Razor offer a fully Integrated Air System (IAS) with no risk of obstructing the crop flow. The air flows at a controlled pressure and uniform speed from behind the knives, which carries the grains back to the belt and ultimately increases yield potential. The IAS minimizes losses due to shattering or when harvesting crops close to the ground, such as soybeans. The Flex 30 and TruFlex Razor offer the perfect combination of flexible components as well as the IAS to maximize yield potential.



- Reduce losses by more than 40% with our Integrated Air System¹
- Fully integrated into the frame
(No obstructing elements, no restriction of the flexibility)
- Air flows directly at the cutterbar
- Easy to operate
- Low maintenance

¹Based on a third party study by Norddeutsche Pflanzenzucht and the Thünen-Institut.

CANOLA KIT

The optional Canola Kit provides efficient and nearly loss-free harvesting of canola and big crops. It consists of two side-mounted vertical knives and a large cross auger. The components are hydraulically driven and can be individually switched on or off.



Canola divider



Cross auger

ADVANTAGES

- ⊕ Optimal crop flow due to the large cross auger
- ⊕ Brightly colored side knives holder for optimal visibility
- ⊕ Quick and tool-free change of side knives

DIVIDERS

Geringhoff offers multiple crop dividers to meet different harvest needs. Dividers are easily changed to adapt to any crop and harvest condition.

ADVANTAGES

- + Clean cutting edge
- + Reduce the losses
- + Quick and tool-free change of the dividers

YOU CAN CHOOSE FROM THE FOLLOWING DIVIDERS:



Soybean divider (standard)



Short divider with clip-on soybean divider



Long divider



Active divider

YOUR SATISFACTION DRIVES US

“

We have all different types of ground from flat to rolling hills. We feel that Geringhoff's TruFlex Razor headers flex better and go over the hills better than the competitors products.

Chris Heintz
Lakeview, Ohio



”

“

After seeing what Geringhoff offers, their products, their warranty, the job it does with these new XDC rollers. I can't say how pleased I am with this Patriot XDC head, along with the performance in the field, it's unbeatable.

Peyton Harper
Trenton, Tennessee



”

“

The flex is unbelievable, until you try it you don't know. When you do try it, you wouldn't want to go back to anything else. On bigger straight cut headers, you always have to make a second pass on ditches, and with Geringhoff you don't have to, it's a one pass deal!

Devin Buhs
Watson, Saskatchewan, Canada



”



“

We ordered this Geringhoff 24 row header because we've seen the numbers on this X9 – the largest machine that John Deere makes. We decided to go with the 24 row to actually feed this machine like it should be. When you have a machine this big, you need a head this big. They work perfect together.

Delbert Armstrong
Pantego, North Carolina

”

“

Last year we bought the Geringhoff Rota Disc. We really like it a lot and saw a reduced horsepower on the combine. Hands down a better head than the competition heads I've had in the past.

Jason Waller
Mer Rouge, Louisiana



”

“



The TruFlex Razor draper helps us cut earlier in the morning and later at night. It flexes right along with the ground. We currently run three of these heads and we love them!

Trey Fliehs
Groton, South Dakota

”

TECHNICAL DATA

NorthStar AFT & NorthStar XDC AFT

Description	Unit	12 Row	16 Row	18 Row
Number of rows		12	16	18
Row width available	in	30	30	30
Transport Width - 30" rigid	ft	30.2	40.0	45.3/22.7
Approximate weight - rigid	lbs	10,000	13,000	14,360



Patriot NorthStar AFT & Patriot NorthStar XDC AFT

Description	Unit	12 Row	16 Row	18 Row
Number of rows		12	16	18
Row width available	in	30	30	30
Transport Width - 30" rigid	ft	30.2	40.0	45.3/22.7
Approximate weight - rigid	lbs	10,150	13,200	14,850



Patriot Rota Disc® AFT

Description	Unit	12 Row	16 Row	18 Row
Number of rows		12	16	18
Row width available	in	30	30	30
Transport Width - 30" rigid	ft	30.2	40.0	45.3/22.7
Approximate weight - rigid	lbs	10,480	13,640	15,300



Rota Disc® AFT

Description	Unit	12 Row	16 Row	18 Row
Number of rows		12	16	18
Row width available	in	30	30	30
Transport Width - 30" rigid	ft	30.2	40.0	45.3/22.7
Approximate weight - rigid	lbs	10,330	13,440	15,120



Freedom NorthStar

Description	Unit	12 Row	16 Row	24 Row	32 Row
Number of rows		12	16	24	32
Working width	ft	15	20	30	40
Transport Width	ft	15.8	20.9	30.8	40.2
Approximate weight NS	lbs	6,350	7,790	11,640	16,170



Freedom Rota Disc®

Description	Unit	12 Row	16 Row	24 Row
Number of rows		12	16	24
Row width available	ft	15	20	30
Transport Width	ft	15.8	20.9	30.8
Approximate weight RD	lbs	6,750	8,320	12,430





Patriot NorthStar & Patriot NorthStar XDC							
Description	Unit	6 Row	8 Row	12 Row	16 Row	18 Row	24 Row
Number of rows		6	8	12	16	18	24
Row width available	in	20/22/30/36/38/40	20/22/30/36/38/40	20/22/30/36/38/40	20/22/30	20/22/30	20/22
Transport Width - 30" rigid/folding	ft	15.4/9.8	20.3/10.8	30.2/15.7	40.0/21.0	45.3/22.7	41.7/21.7
Approximate weight rigid/folding	lbs	3,955/4,530	5,370/6,175	7,670/8,845	10,860/12,480	12,630	13,990/15,370



Patriot Rota Disc®							
Description	Unit	6 Row	8 Row	12 Row	16 Row	18 Row	24 Row
Number of rows		6	8	12	16	18	24
Row width available	in	20/22/30/36/38/40	20/22/30/36/38/40	20/22/30/36/38/40	20/22/30	20/22/30	20/22
Transport Width - 30" rigid/folding	ft	15.4/9.8	20.3/10.8	30.2/15.7	40.0/21.0	45.3/22.7	41.7/N/A
Approximate weight rigid/folding	lbs	4,165/4,880	5,615/6,605	9,045/9,645	11,345/12,945	13,180	14,790/16,190



Rota Disc®								
Description	Unit	4 Row	6 Row	8 Row	12 Row	16 Row	18 Row	24 Row
Number of rows		4	6	8	12	16	18	24
Row width available	in	30/36/38/40	20/22/30/36/38/40	20/22/30/36/38/40	20/22/30/36/38/40	20/22/30	20/22/30	20/22
Transport Width - 30" rigid/folding	ft	10.5/9.8	15.4/9.8	20.3/10.8	30.2/15.7	40.0/21.0	45.3/22.7	45.4/23.1
Approximate weight rigid/folding	lbs	2,840	4,105/4,820	5,535/6,435	8,925/9,220	11,185/12,750	13,000	14,850/16,255



NorthStar & NorthStar XDC								
Description	Unit	4 Row	6 Row	8 Row	12 Row	16 Row	18 Row	24 Row
Number of rows		4	6	8	12	16	18	24
Row width available	in	30/36/38/40	20/22/30/36/38/40	20/22/30/36/38/40	20/22/30/36/38/40	20/22/30	20/22/30	20/22
Transport Width - 30" rigid/folding	ft	10.5/9.8	15.4/9.8	20.3/10.8	30.2/15.7	40.0/21.0	45.3/22.7	41.7/21.7
Approximate weight rigid/folding	lbs	2,665	3,895/4,470	5,290/6,095	7,550/8,725	10,700/12,320	12,450	13,750/15,130

Please note

The specified transport width and weight values are approximate and for reference only. The values in the chart are based on a standard-spec head offering a row width of 30". Please contact Geringhoff for information on other models and exact specifications.

TECHNICAL DATA



NorthStar Horizon							
Description	Unit	4 Row	6 Row	8 Row	12 Row	16 Row	18 Row
Number of rows		4	6	8	12	16	18
Row width available	in	30	20/22/30/36/38/40	20/22/30/36/38/40	20/22/30/36/38/40	20/22/30	20/22/30
Transport Width - 30" rigid/folding	ft	10.5/N/A	15.4/9.8	20.3/10.8	30.2/15.7	40.0/21.0	45.3/22.7
Approximate weight rigid/folding	lbs	3,420	4,700	5,830/7,240	9,880/10,170	12,300/14,400	14,150



NorthStar Horizon Stover Collect				
Description	Unit	6 Row	8 Row	12 Row
Number of rows		6	8	12
Row width available	in	30	30	30
Transport Width - 30"	ft	15.4	20.3	30.2
Approximate weight	lbs	6,200	7,050	10,600



SunLite				
Description	Unit	25 Feet	30 Feet	40 Feet
Working width	ft	25	30	40
Pan width	in	7	7	7
Approximate weight	lbs	4,550	5,250	6,860



MiloStar					
Description	Unit	6 Row	8 Row	12 Row	16 Row
Number of rows		6	8	12	16
Row width available	in	30/36/38/40	30/36/38/40	30/36/38/40	30
Transport Width - 30"	ft	15.4	20.3	30.2	40.0
Approximate weight	lbs	4,130	5,490	7,950	10,860

Please note

The specified transport width and weight values are approximate and for reference only. The values in the chart are based on a standard-spec head offering a row width of 30". Please contact Geringhoff for information on other models and exact specifications.



		Flex	TruFlex Razor		
		30'	35'	40'	45'
Description	Unit	Dimensions	Dimensions		
Working width	ft (m)	30 (9.15)	35 (10.65)	40 (12.20)	45 (13.70)
Outer width	ft (m)	31 (9.44)	35.73 (10.89)	40.73 (12.42)	45.73 (13.94)
Description	Unit	Weight	Weight		
Tare weight	lbs (kg)	6,150 (2,790)	8,650 (3,925)	8,900 (4,035)	9,150 (4,150)
+ IAS	lbs (kg)	800 (363)	850 (385)	900 (410)	950 (430)
+ Canola-Kit ¹	lbs (kg)	550 (250)	618 (280)	660 (300)	705 (320)
Description	Unit	Flexibility	Flexibility		
Frame	Type	Single section reel	Three-piece	Three-piece	Three-piece
	Flexibility	-	Yes	Yes	Yes
	Flex range °	-	+4 / -5	+4 / -5	+4 / -5
	Flex range in (mm)	-	20.5 (520)	25 (640)	30 (760)
Cutterbar	Flexibility	Yes	Yes	Yes	Yes
	Flex range in (mm)	6 (150)	6 (150)	6 (150)	6 (150)
Total flex range	in (mm)	6 (150)	26.5 (670)	31 (790)	36 (910)
Height control system	Grain	2 sensors, 4 drag rods	4 sensors, 8 drag rods	4 sensors, 8 drag rods	4 sensors, 8 drag rods
	Soybean	6 sensors	8 sensors	8 sensors	8 sensors
Support wheel	Availability	-	Hydraulic	Hydraulic	Hydraulic
Description	Unit	Draper/Feed	Draper/Feed		
Side belts depth	in (mm)	41 (1,043)	41 (1,043)	41 (1,043)	41 (1,043)
Side belts speed	mph (m/s)	0-8 (0-3.6)	0-8 (0-3.6)	0-8 (0-3.6)	0-8 (0-3.6)
Center belt width	in (mm)	86.6 (2,200)	86.6 (2,200)	86.6 (2,200)	86.6 (2,200)
Center belt speed	mph (m/s)	0-8 (0-3.6)	0-8 (0-3.6)	0-8 (0-3.6)	0-8 (0-3.6)
Feed auger diameter	in (mm)	24.4 (620)	24.4 (620)	24.4 (620)	24.4 (620)
Feed auger width	in (mm)	70.9 (1,800)	70.9 (1,800)	70.9 (1,800)	70.9 (1,800)
Cross auger diameter	in (mm)	13.8 (350)	13.8 (350)	13.8 (350)	13.8 (4,200)
Description	Unit	Cutting system	Cutting system		
Drive		Central, hydraulic, dual knife drive	Central, hydraulic, dual knife drive	Central, hydraulic, dual knife drive	Central, hydraulic, dual knife drive
Safety		Relief valve	Relief valve	Relief valve	Relief valve
Sickle manufacturer		Schumacher	Schumacher	Schumacher	Schumacher
Available sickle teeth per in	TPI	14, 11, 7	14, 11, 7	14, 11, 7	14, 11, 7
Speed	Cuts per min	1,350	1,350	1,350	1,350
Description	Unit	Reel	Reel		
Reel	Type	Flip Over	Flip Over	Flip Over	Flip Over
Diameter	in (mm)	46.5 (1,180)	46.5 (1,180)	46.5 (1,180)	46.5 (1,180)
Section		Single-section	Three-piece	Three-piece	Three-piece
Reel tine material		Poly	Poly	Poly	Poly
Distance between reel tines	in (mm)	6 (150)	6 (150)	6 (150)	6 (150)

While we make efforts to ensure accuracy, please note that all programs, pricing and products specs are subject to change without notice. Some images may vary from final product. Illustrations and pictures may include special items or kits. All statements and values depend on different harvesting conditions.

Find your local Geringhoff representative at [Geringhoff.com/contact](https://geringhoff.com/contact)



In Field Service Hotline

Tel: (888) 721-1340
E-Mail: service@geringhoff.com

3405 Energy Drive
St. Cloud, MN 56304

Phone: (320) 252-4633
E-Mail: info@geringhoff.com

[Geringhoff.com](https://geringhoff.com)

Follow Geringhoff on Social Media:

